

# Left cell graphs and distinguished elements in $W_{(4)}$ of $\tilde{E}_k, k = 6, 7, 8$

Jian-yi Shi and Xi-gou Zhang

For  $k \in \{6, 7, 8\}$  and  $X = A, B, \dots$ , Figures  $(\tilde{E}_k, X)$  denotes the left cell graphs in  $W_{(4)}$  of the affine Weyl group  $\tilde{E}_k$ , while Figures  $(\tilde{E}_k, X')$  are used to chase the distinguished involutions in the left cells occurring as vertices of Figures  $(\tilde{E}_k, X)$ . Note that in the Appendix of the paper “Left cells with  $a$ -value 4 in the affine Weyl groups  $\tilde{E}_i$  ( $i = 6, 7, 8$ )”, we combine Figures  $(\tilde{E}_6, X)$  and  $(\tilde{E}_6, X')$  into a single Figure X for any  $X \in \{A, B, C, D\}$  for the sake of saving space. See 6.10 and Appendix in the paper for the explanation of the graphs.

Figures  $(\tilde{E}_8, A_1)$  and  $(\tilde{E}_8, A_2)$  (respectively, Figures  $(\tilde{E}_8, B_1)$  and  $(\tilde{E}_8, B_2)$ ) comprise one left cell graph. Any of the other figures itself forms a left cell graph.

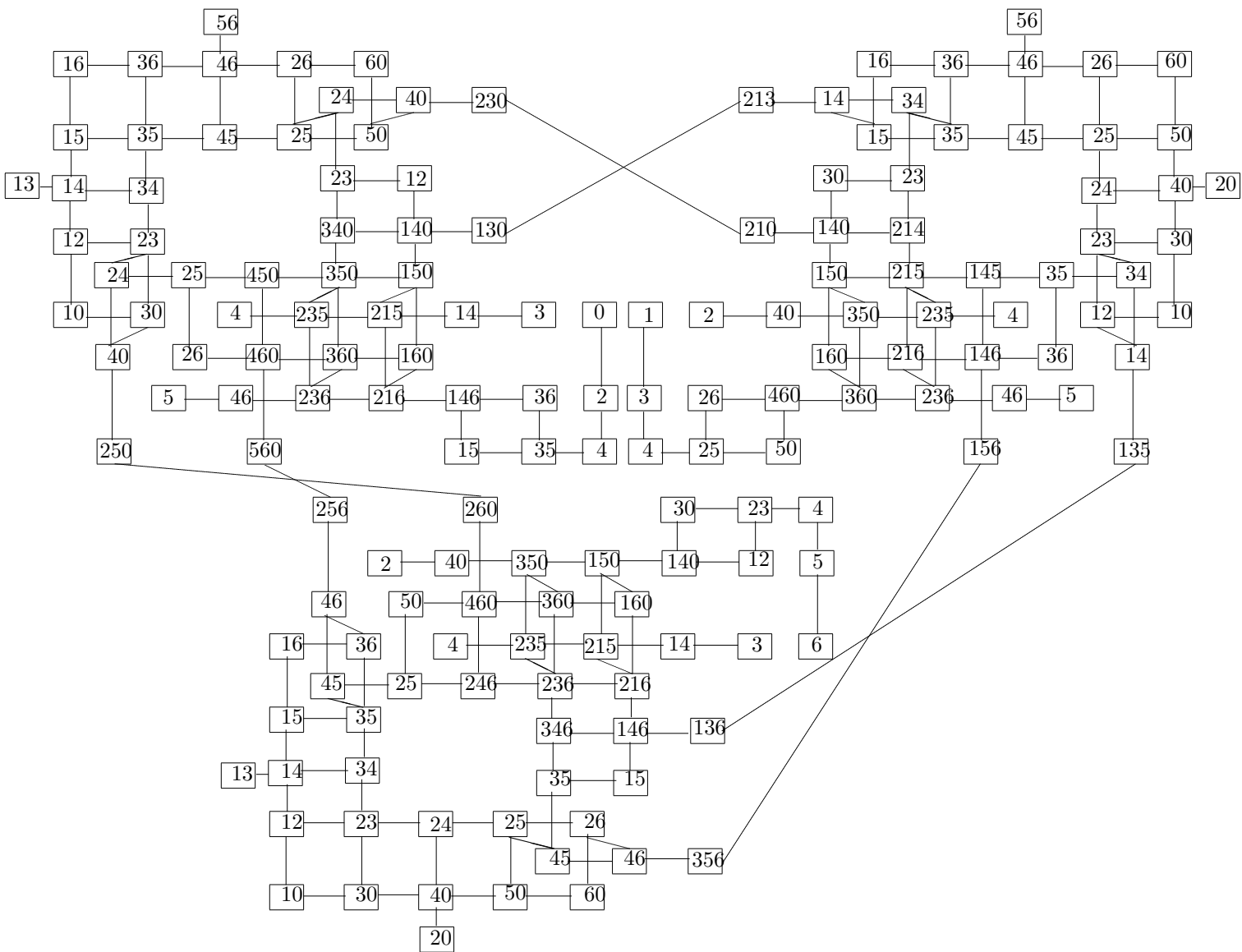

Figure.  $\tilde{E}_6, A$

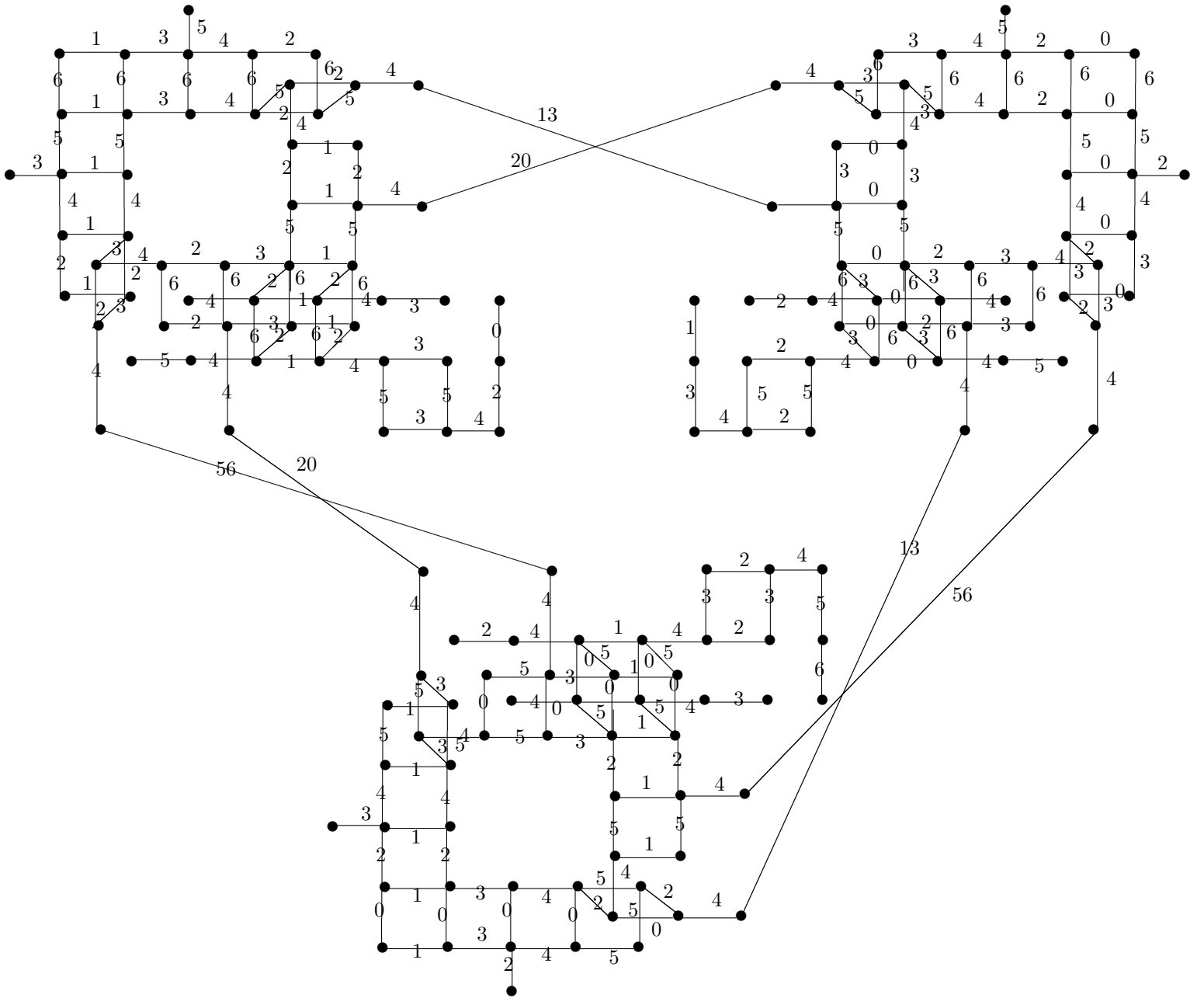

Figure.  $\tilde{E}_6, A'$

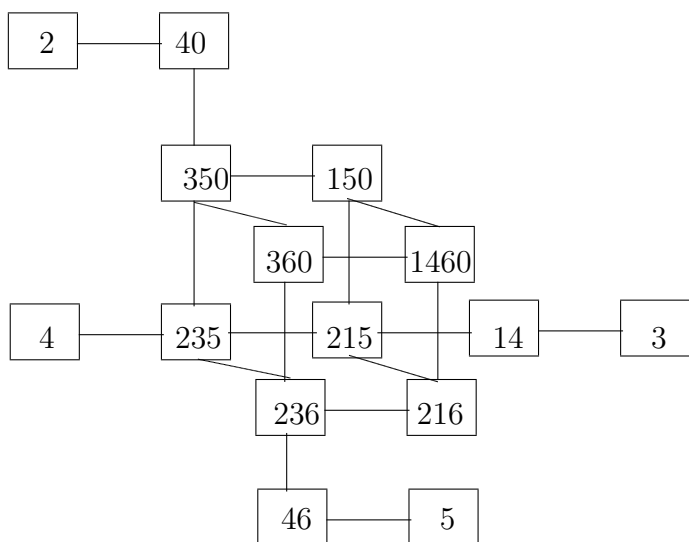

Figure.  $\tilde{E}_6, B$

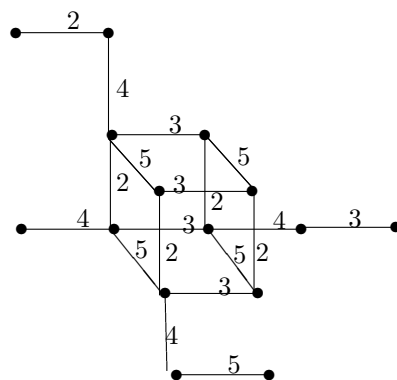

Figure.  $\tilde{E}_6, B'$

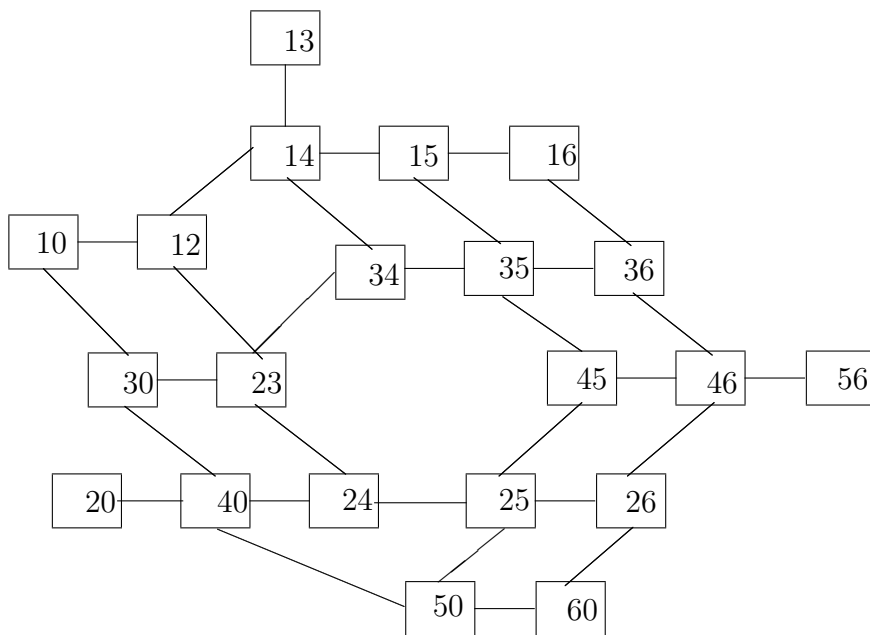

Figure.  $\tilde{E}_6, C$

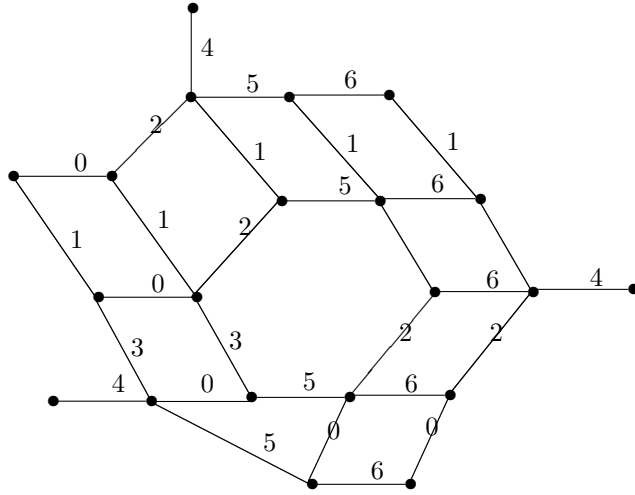

Figure.  $\tilde{E}_6, C'$

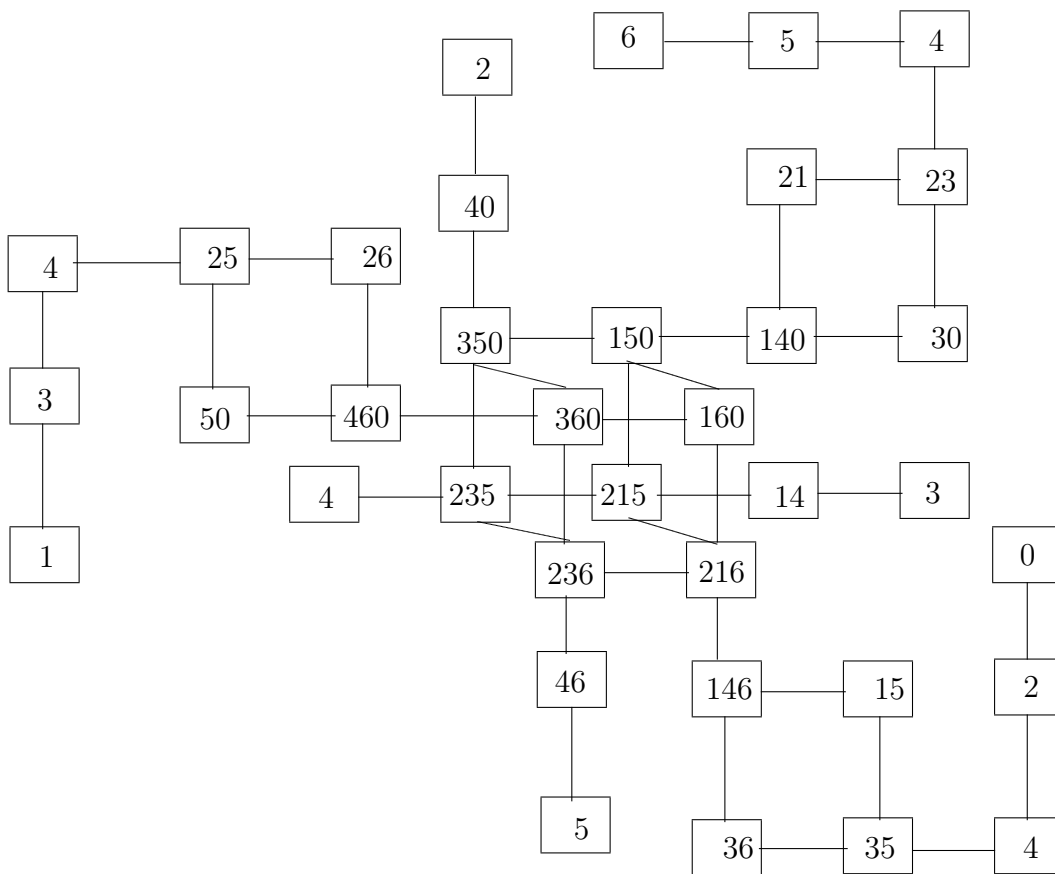

Figure.  $\tilde{E}_6, D$

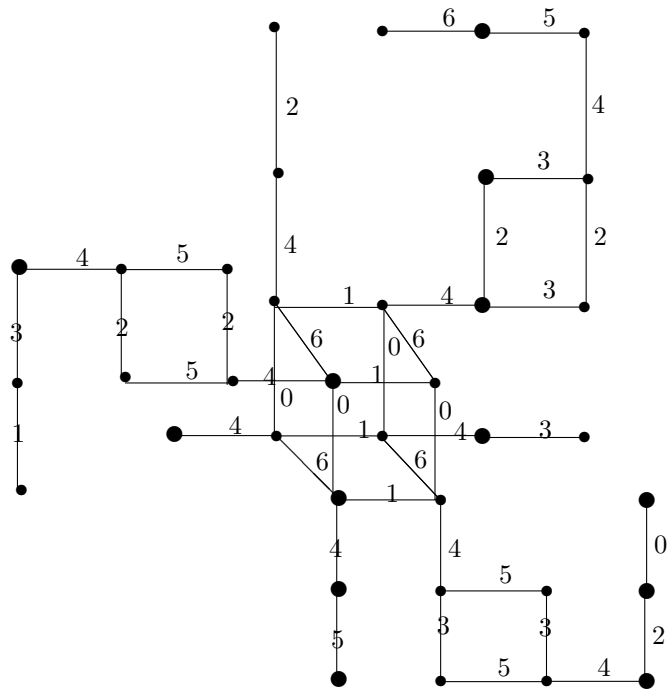

Figure.  $\tilde{E}_6, D'$



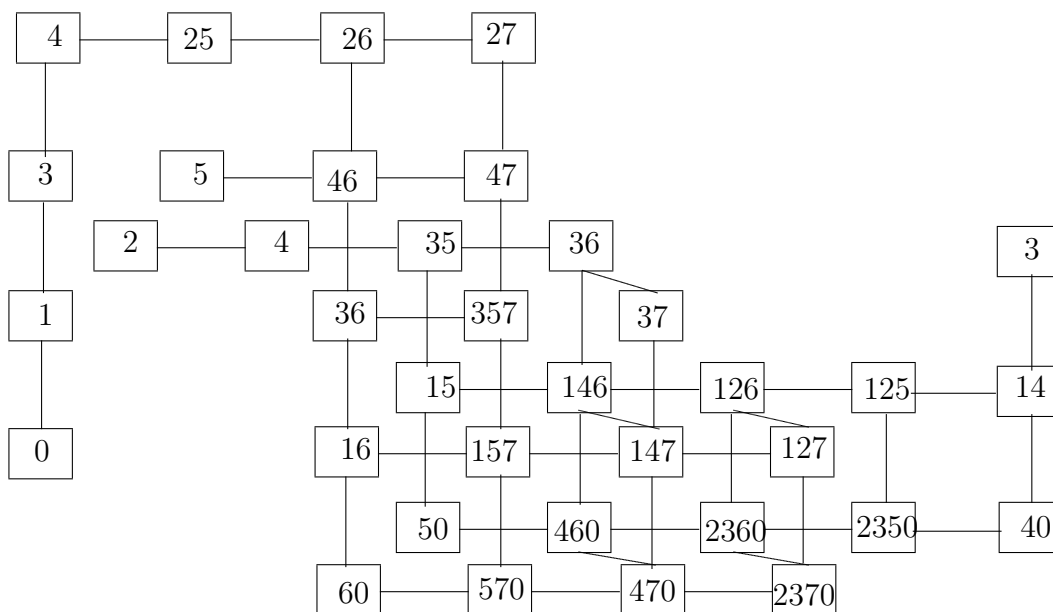

Figure.  $\tilde{E}_7, A$

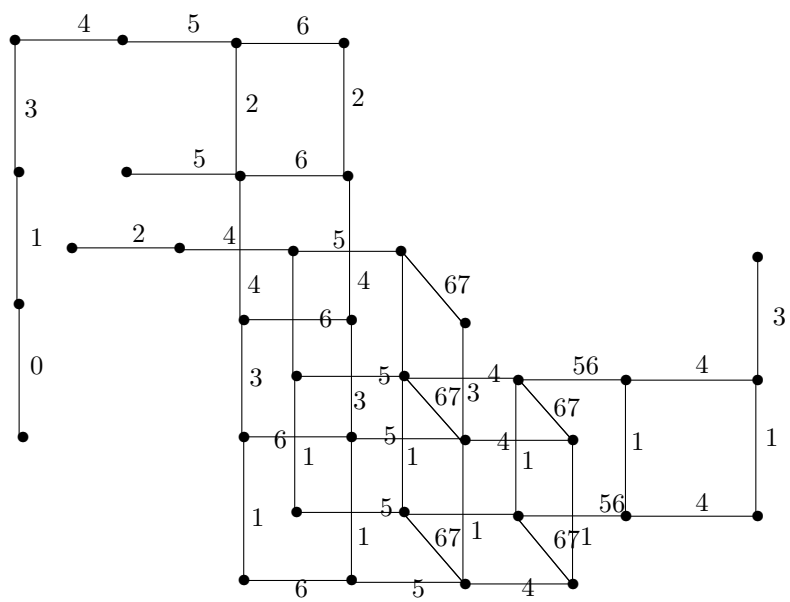

Figure.  $\tilde{E}_7, A'$

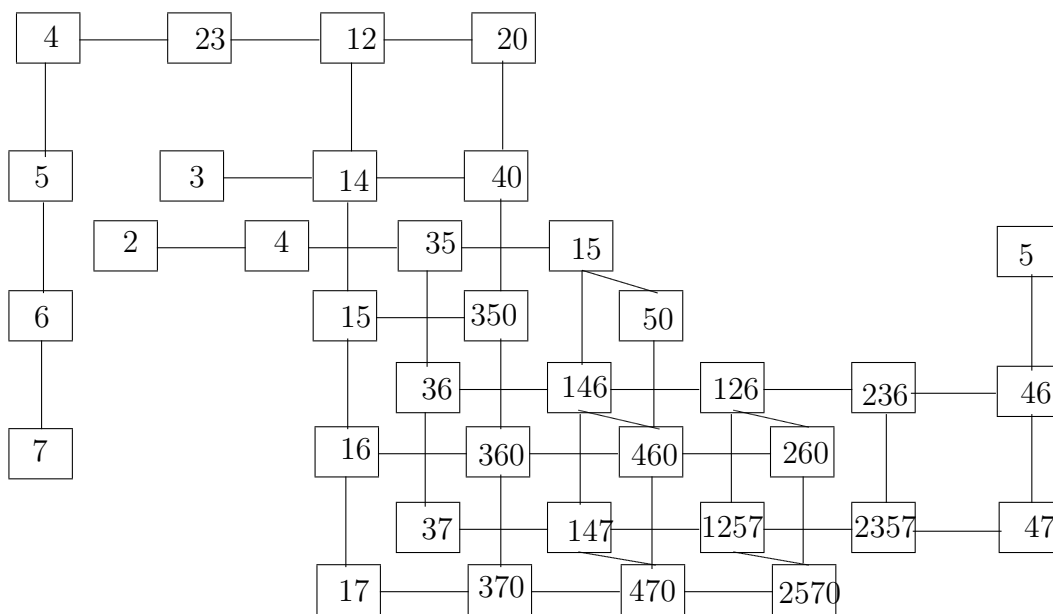

Figure.  $\tilde{E}_7$ , B

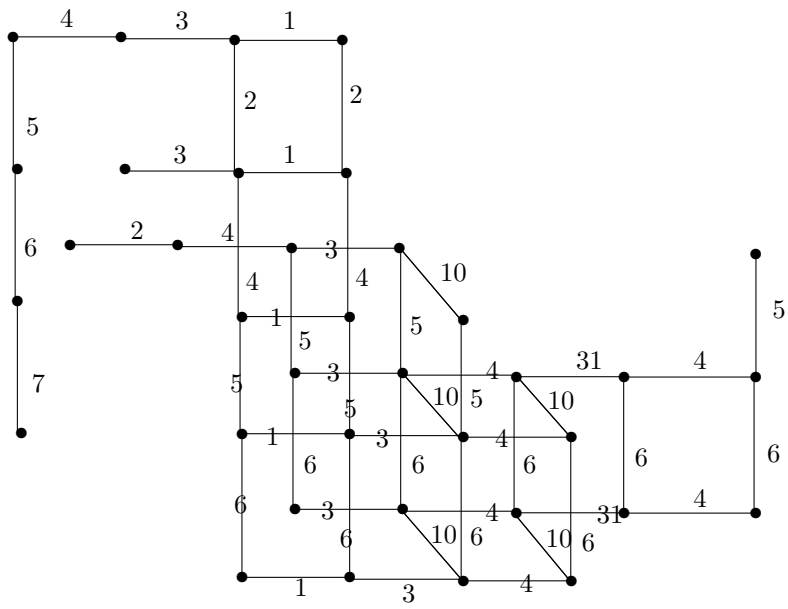

Figure.  $\tilde{E}_7, B'$

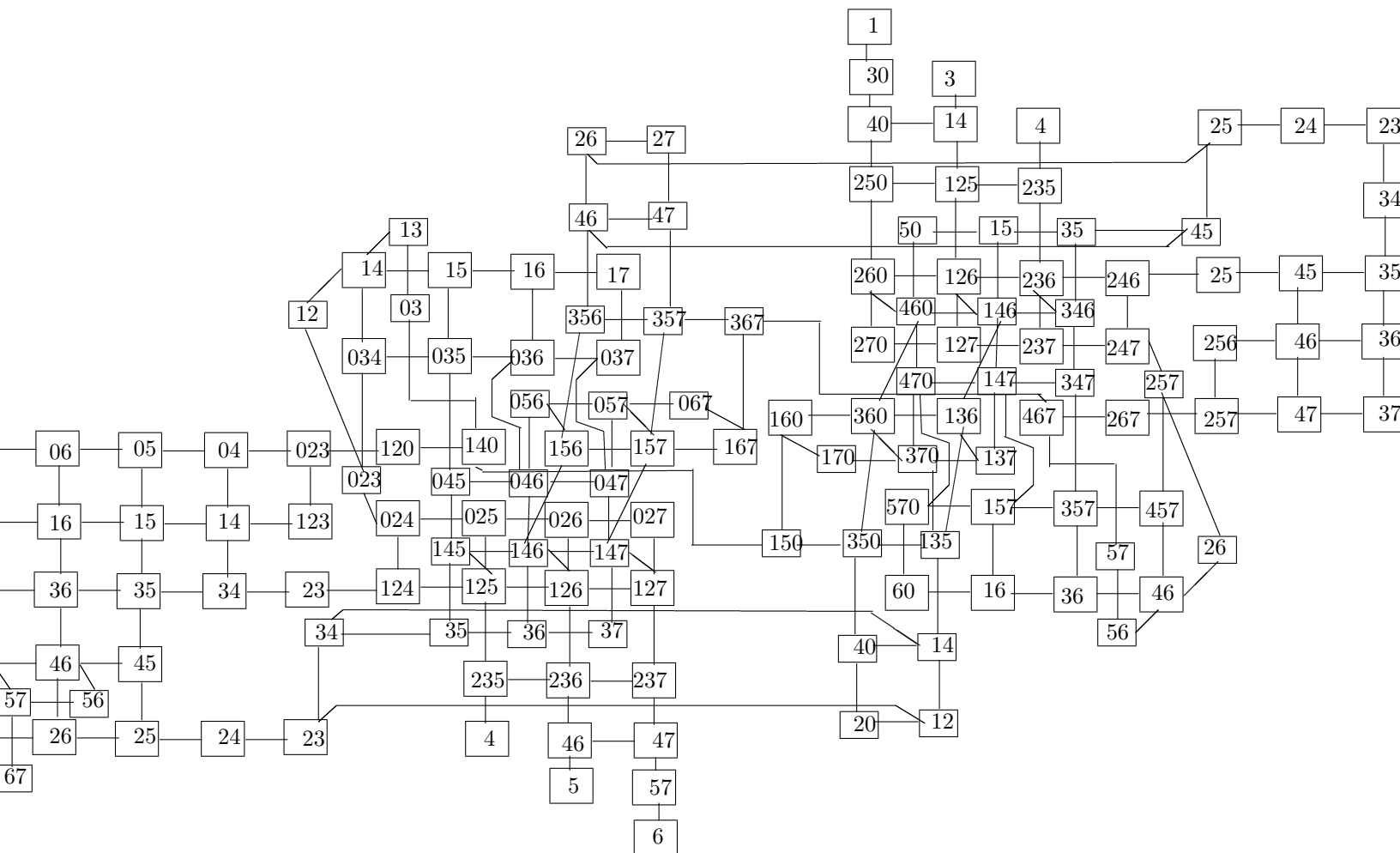

Figure.  $\tilde{E}_7, C$

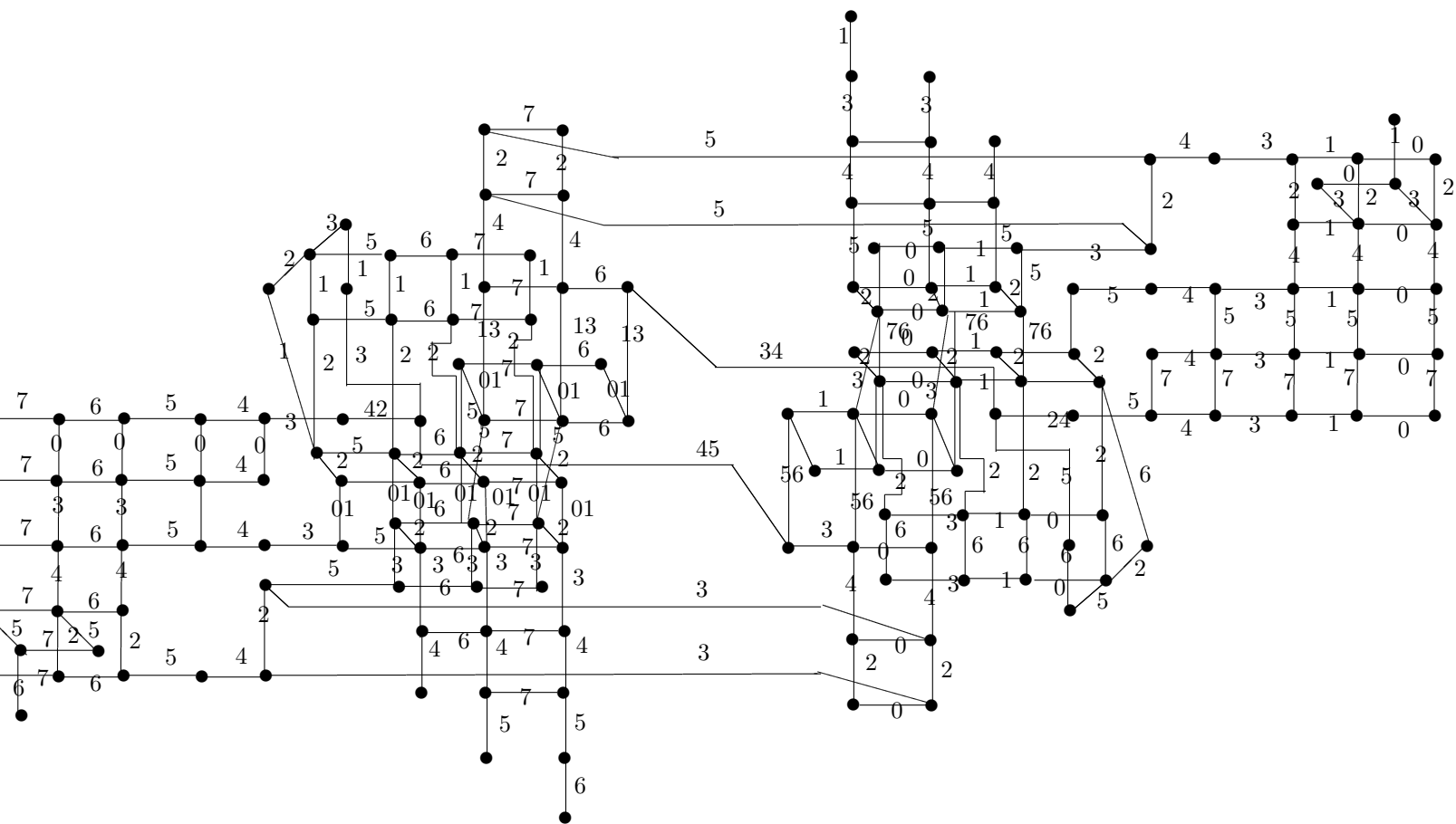

Figure.  $\tilde{E}_7, C'$

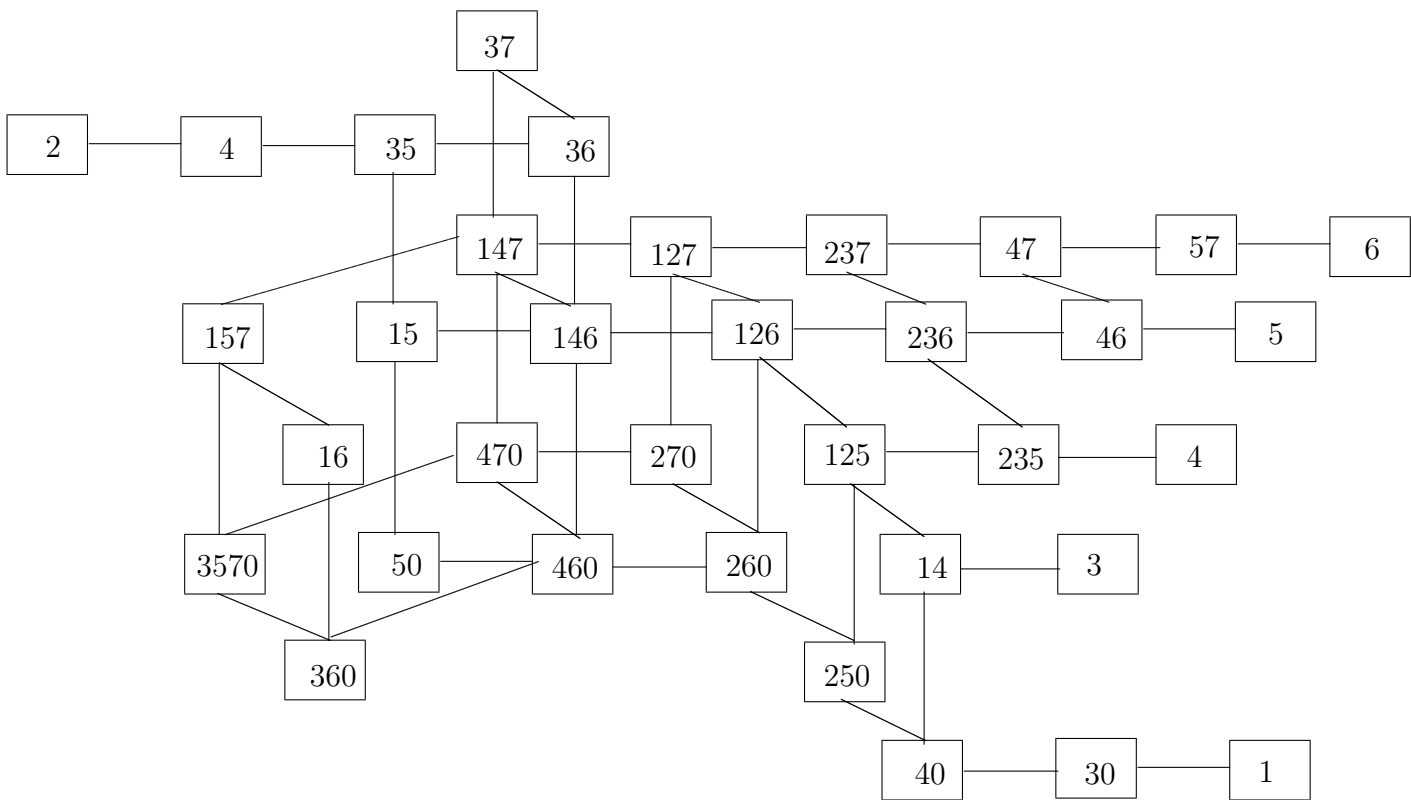

Figure.  $\tilde{E}_7, D$

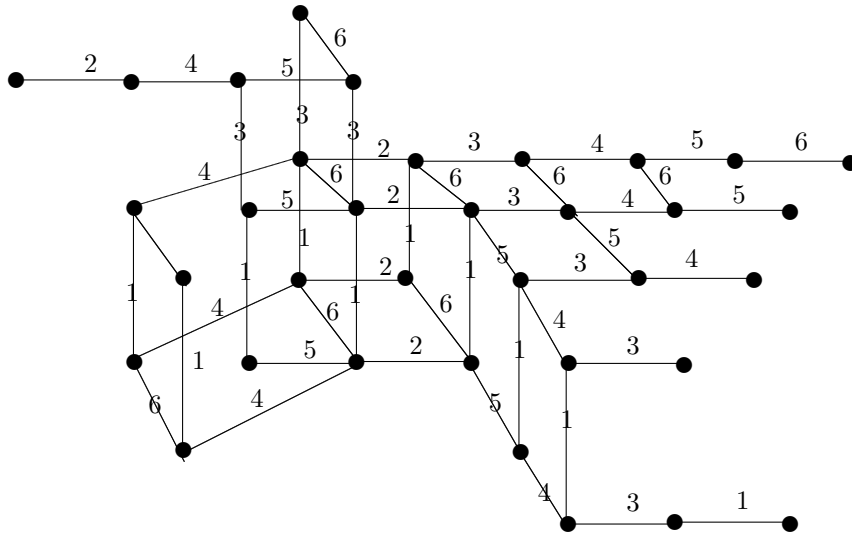

Figure.  $\tilde{E}_7, D'$



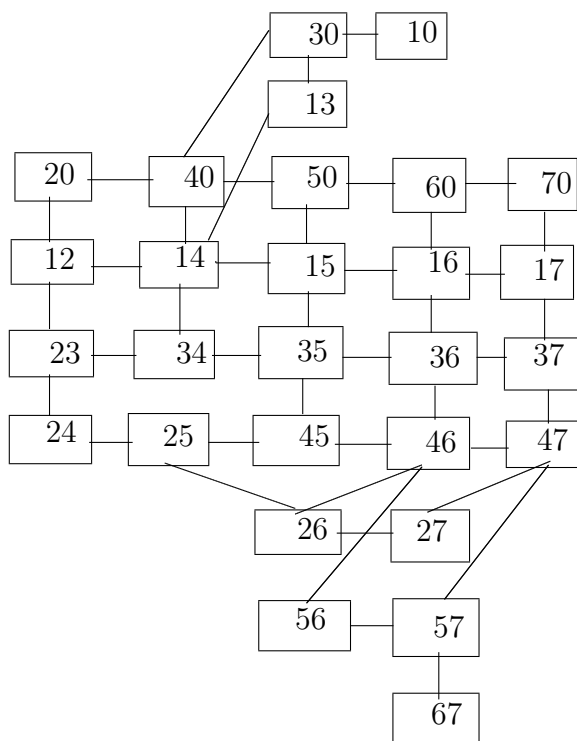

Figure.  $\tilde{E}_7, E$

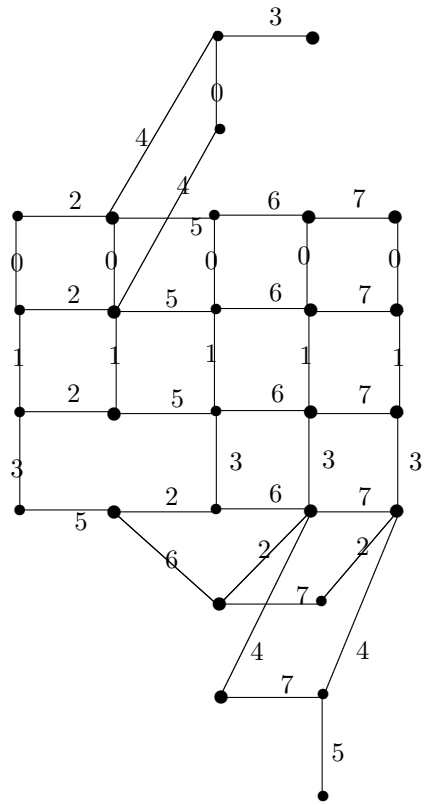

Figure.  $\tilde{E}_7, E'$

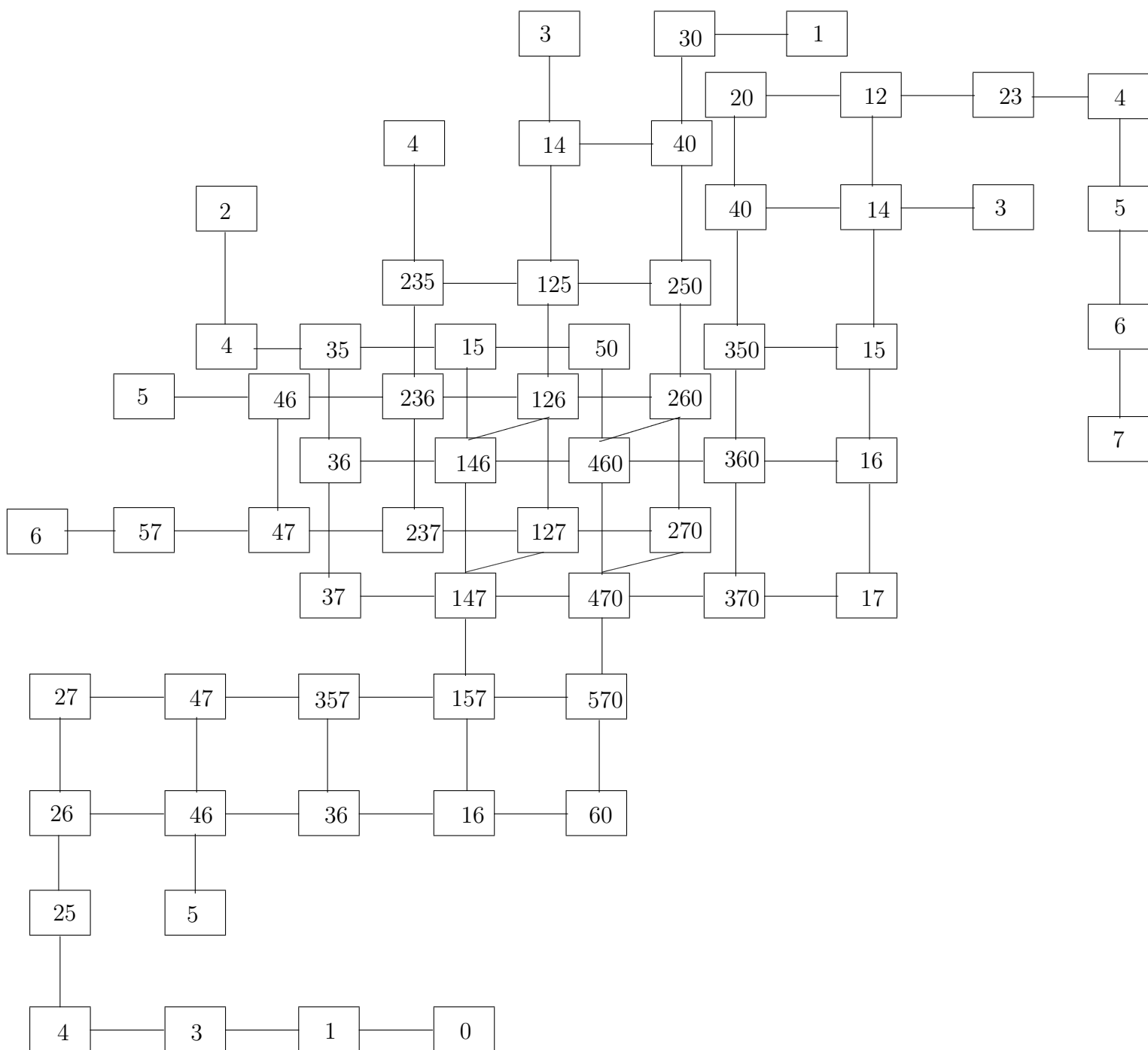

Figure.  $\tilde{E}_7, F$

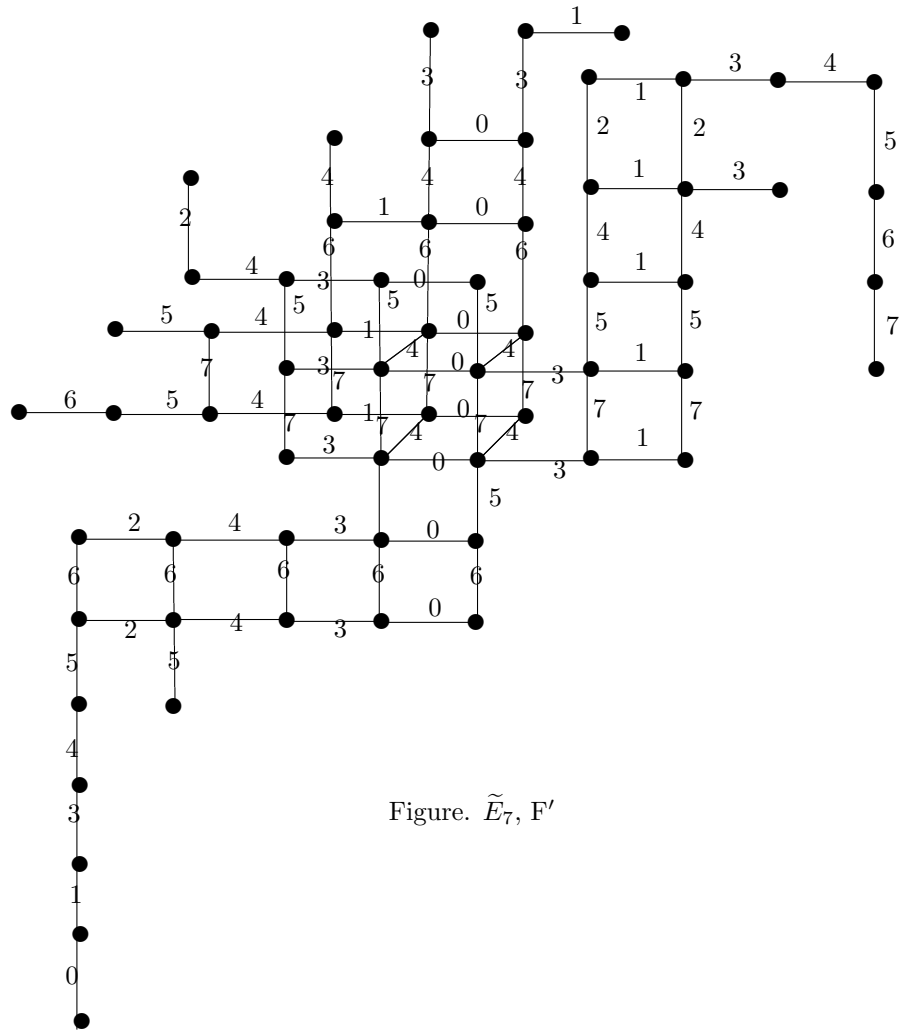

Figure.  $\tilde{E}_7, F'$

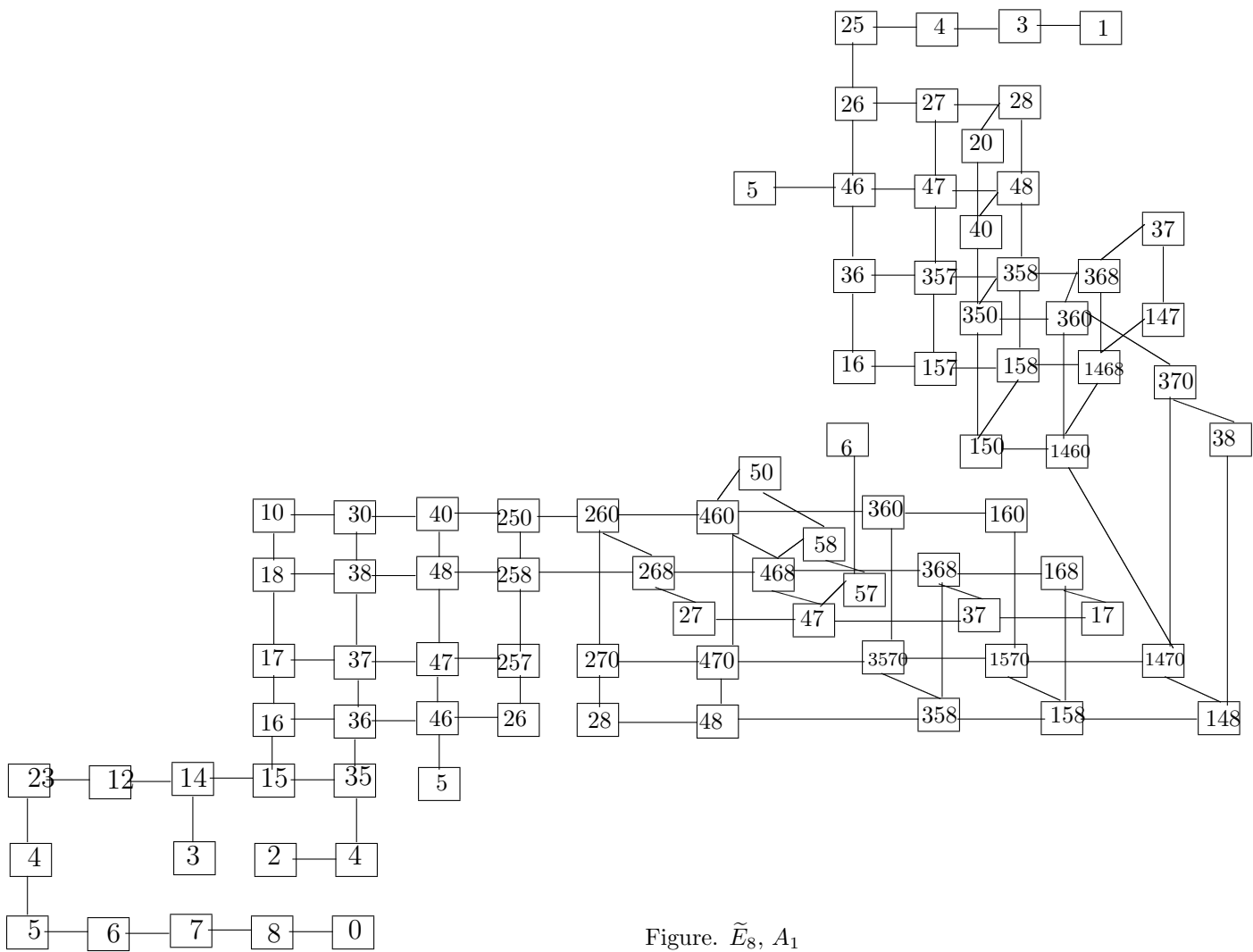

Figure.  $\tilde{E}_8, A_1$

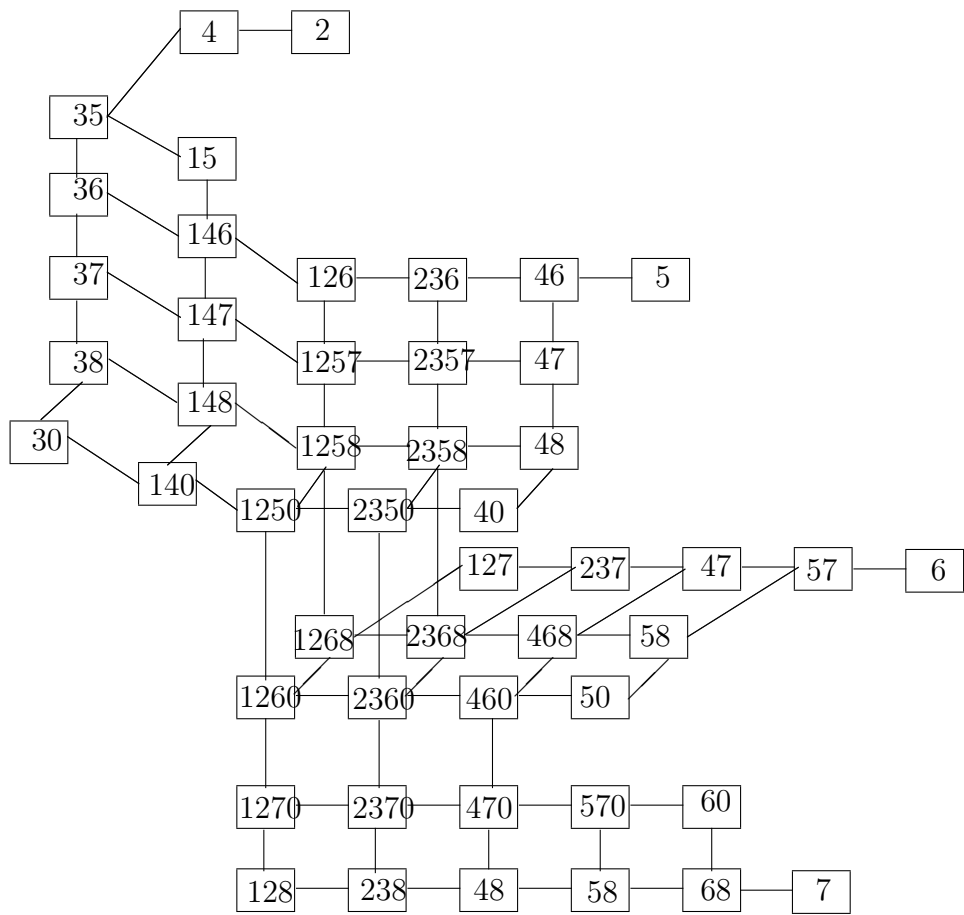

Figure.  $\tilde{E}_8, A_2$

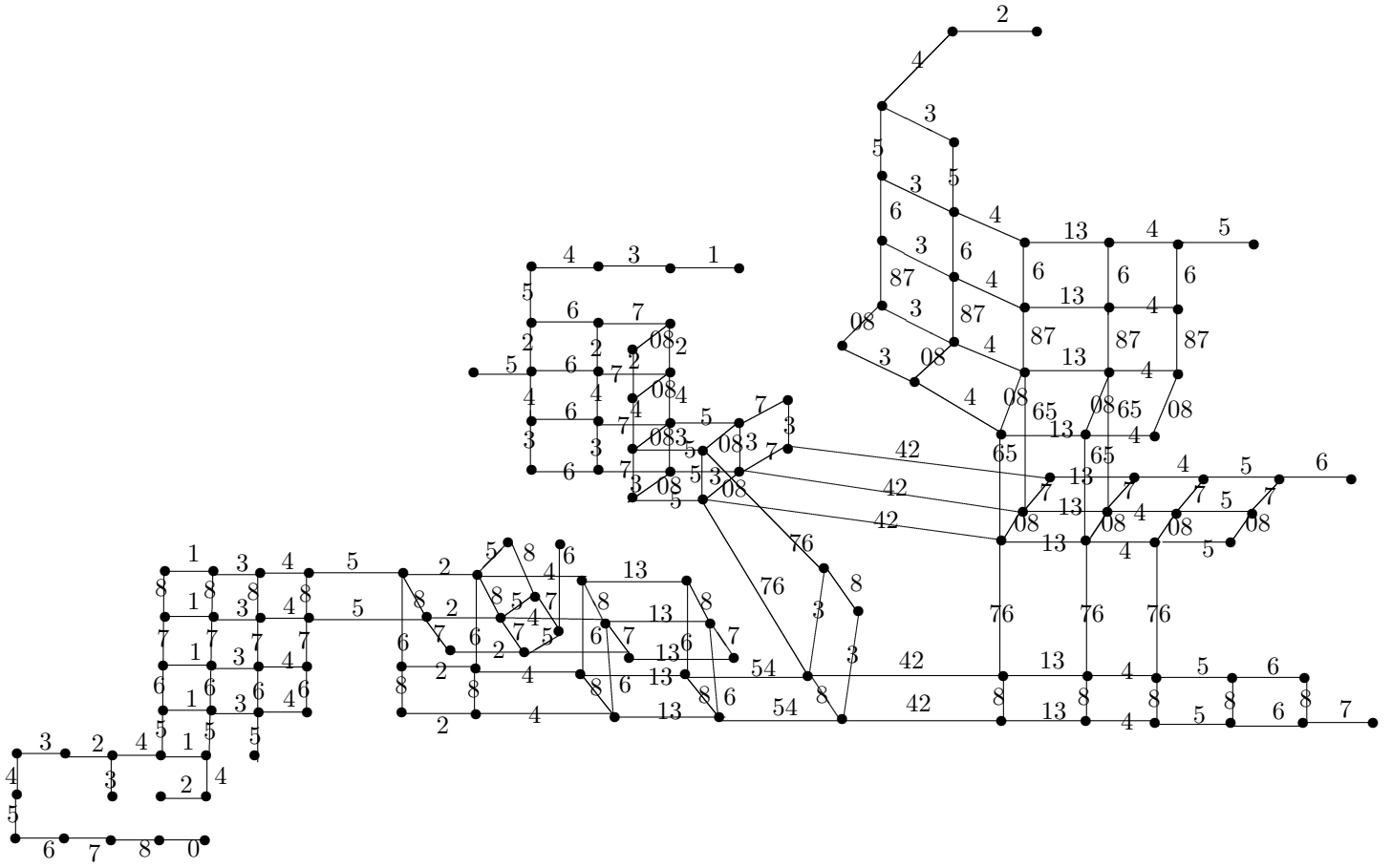

Figure.  $\tilde{E}_8, A'$

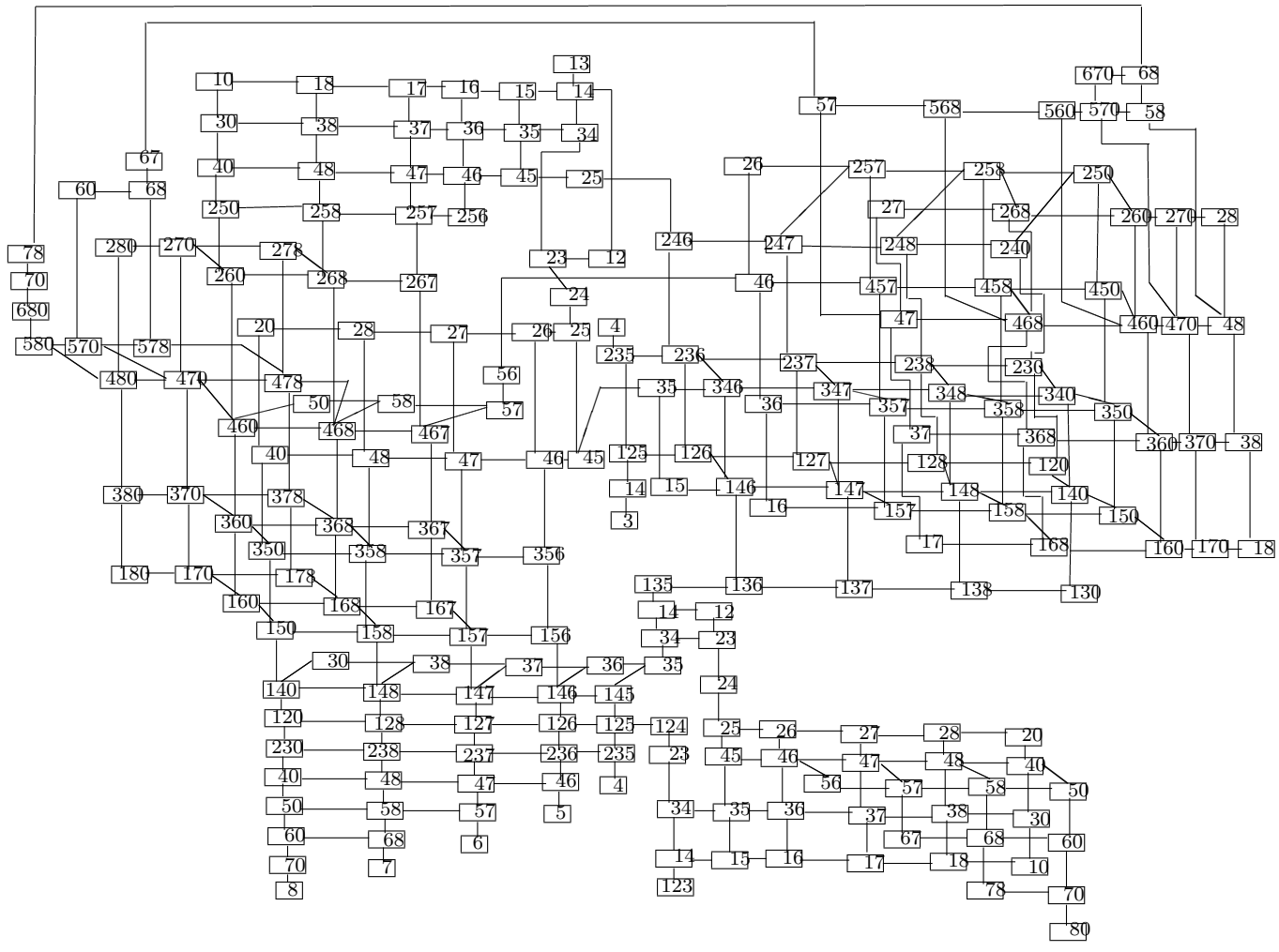

Fig.  $\tilde{E}_8$ , B



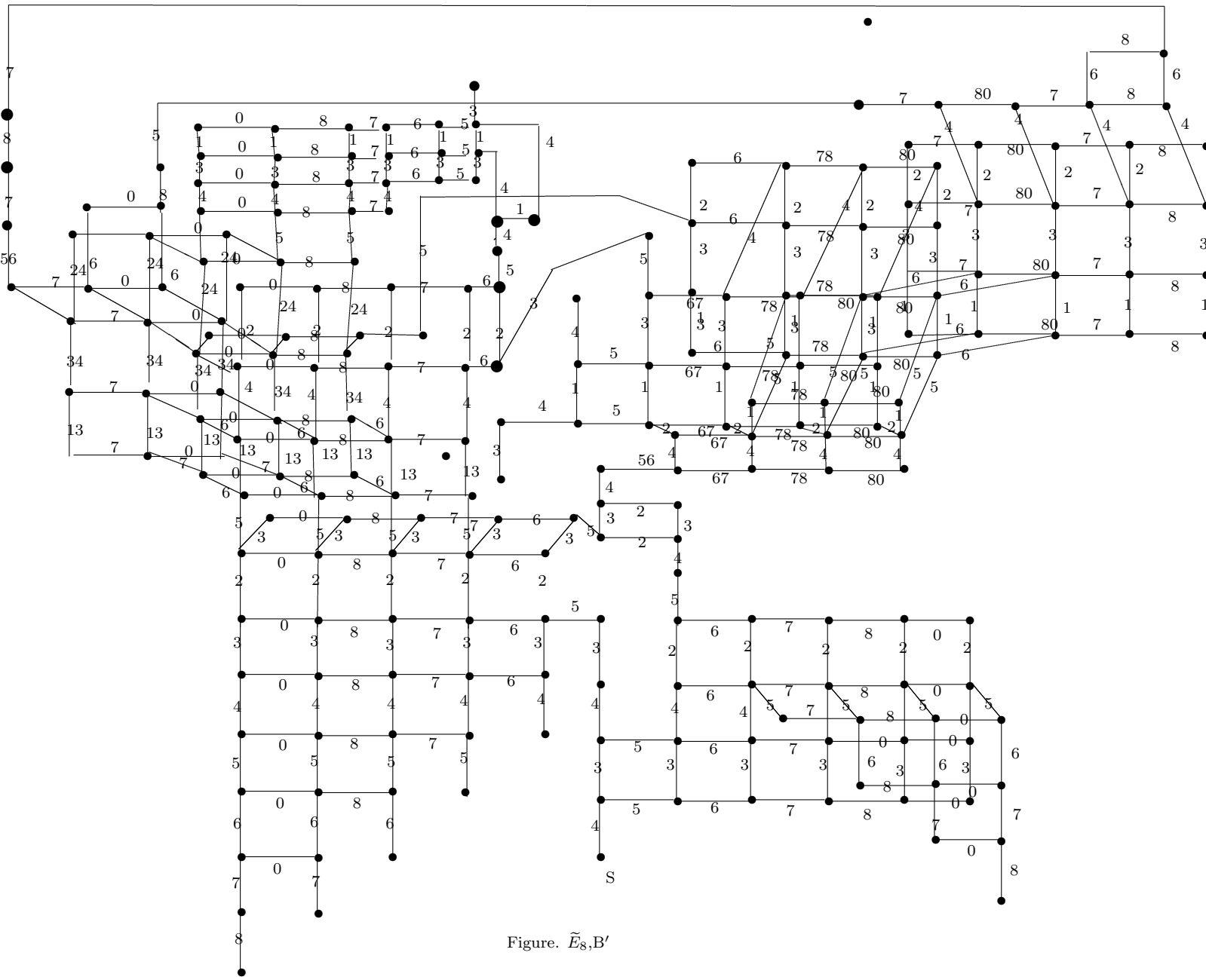

Figure.  $\tilde{E}_{8,B'}$

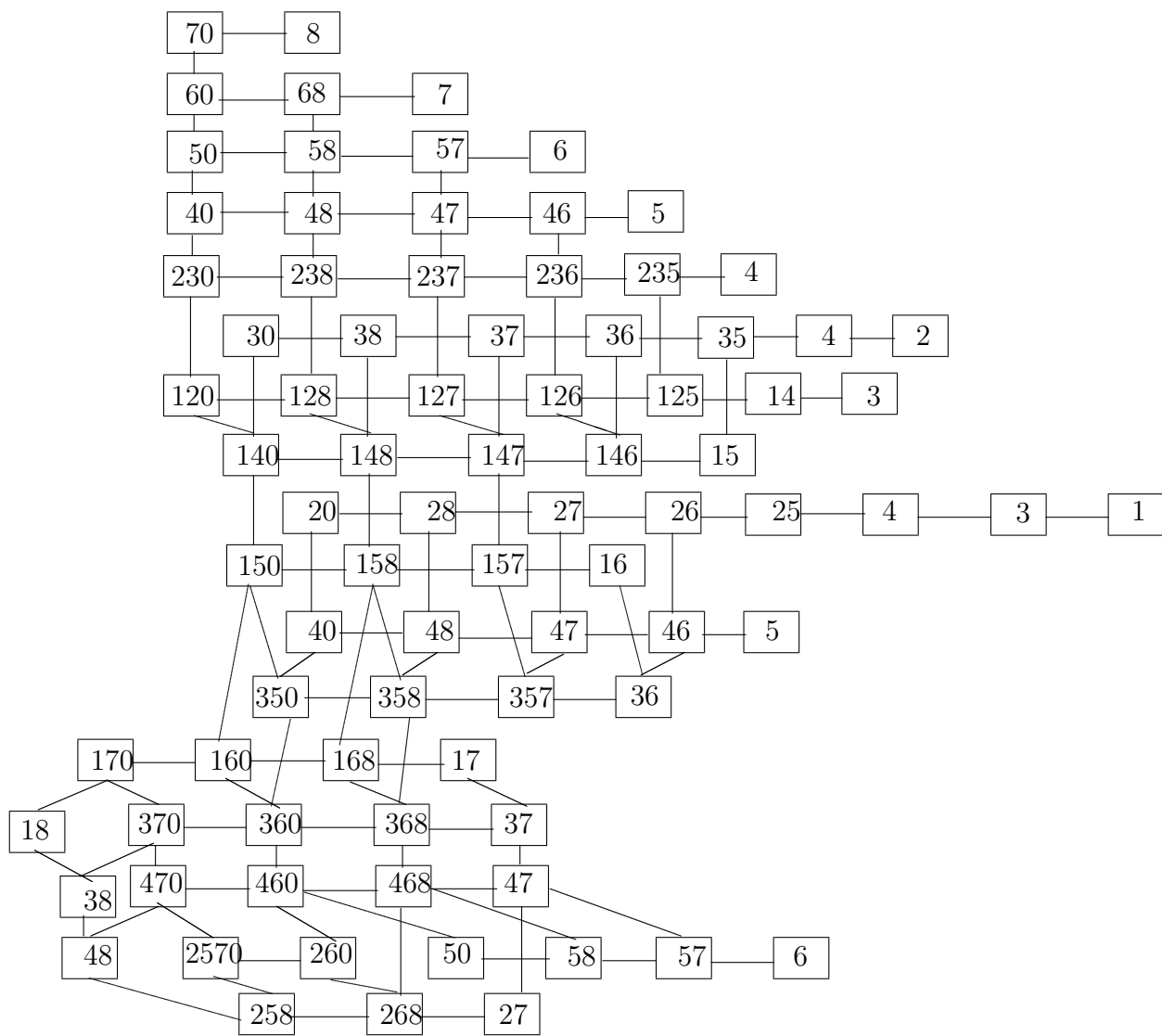

Figure.  $\tilde{E}_8, C$

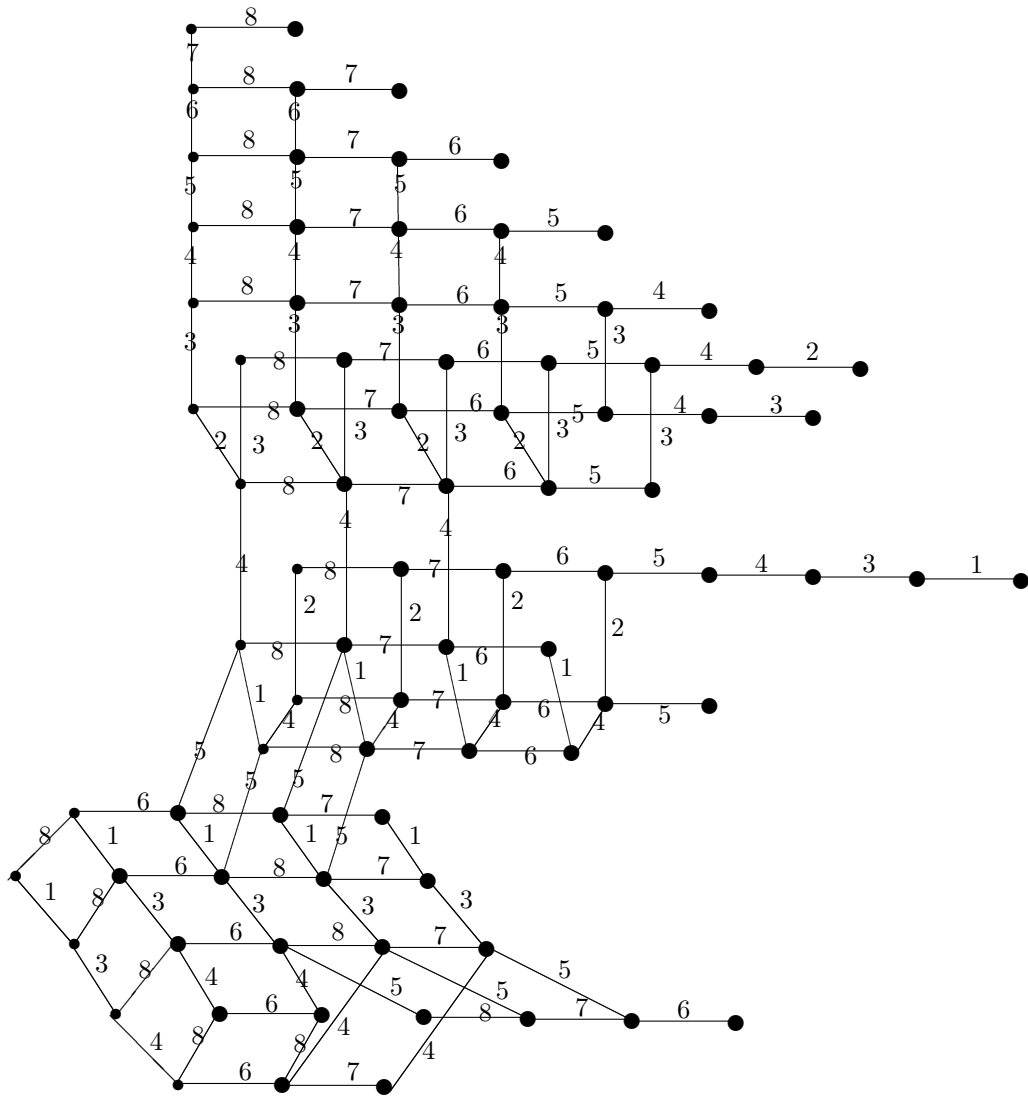

Figure.  $\tilde{E}_8, C'$

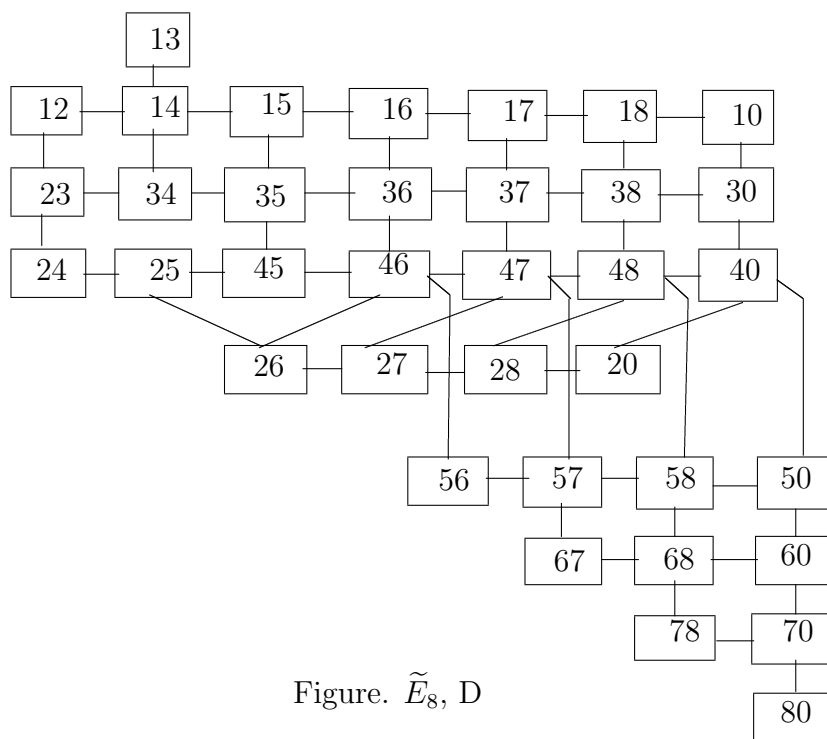

Figure.  $\tilde{E}_8, D$

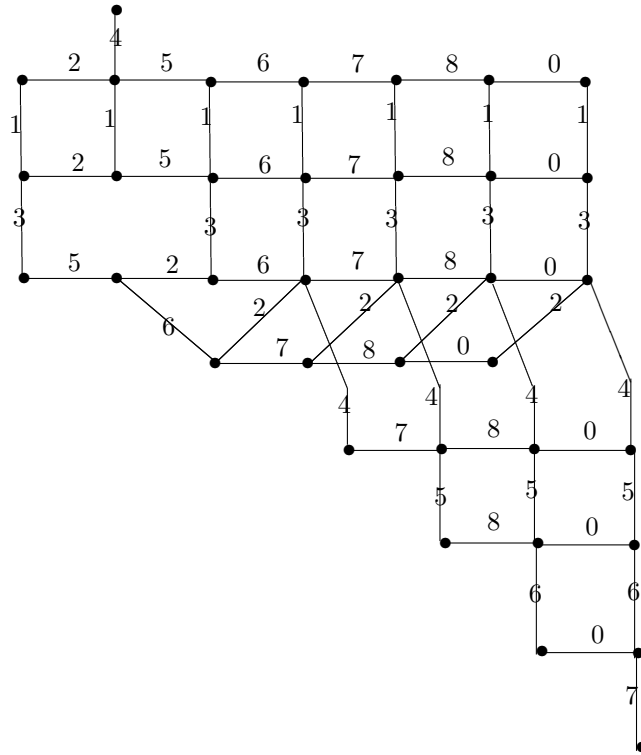

Figure.  $\tilde{E}_8, D'$

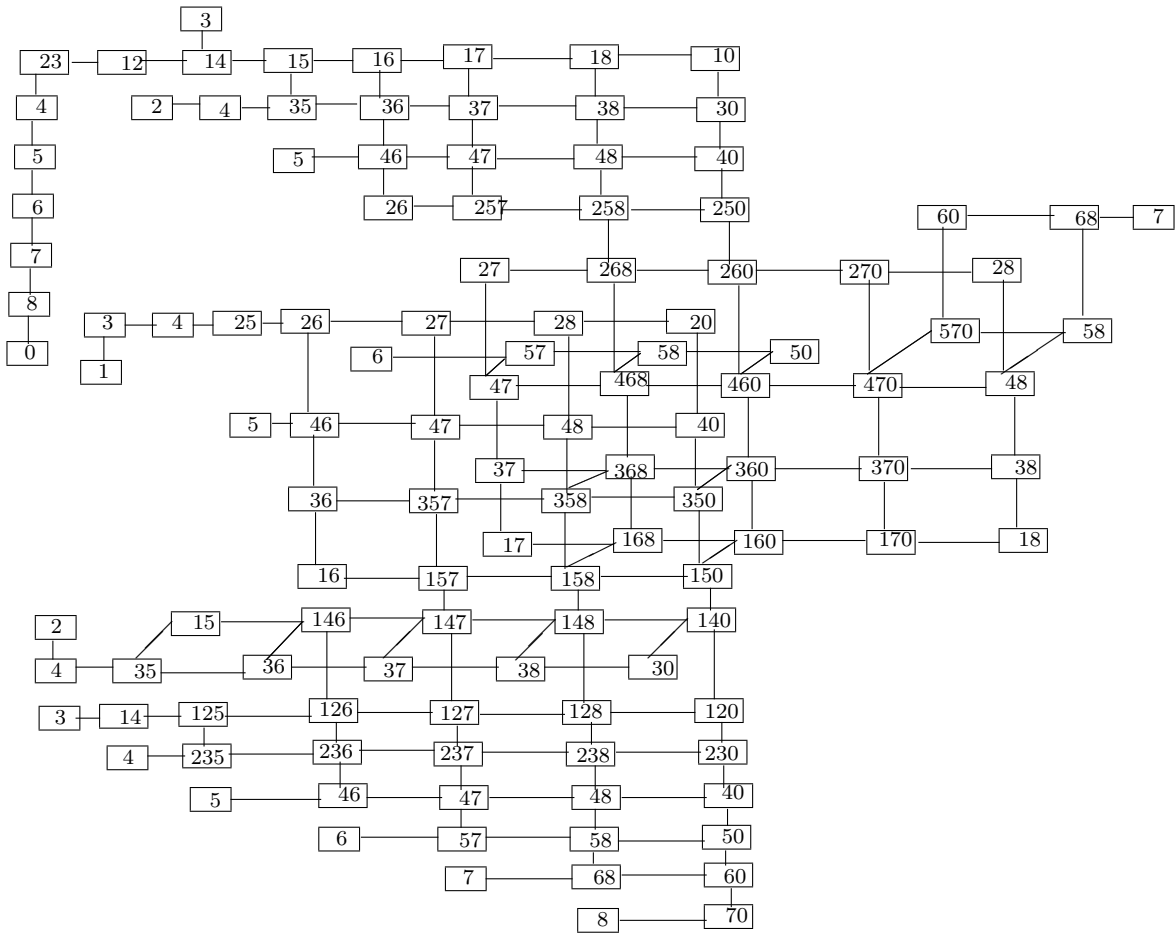

Fig.  $\tilde{E}_8$ , E

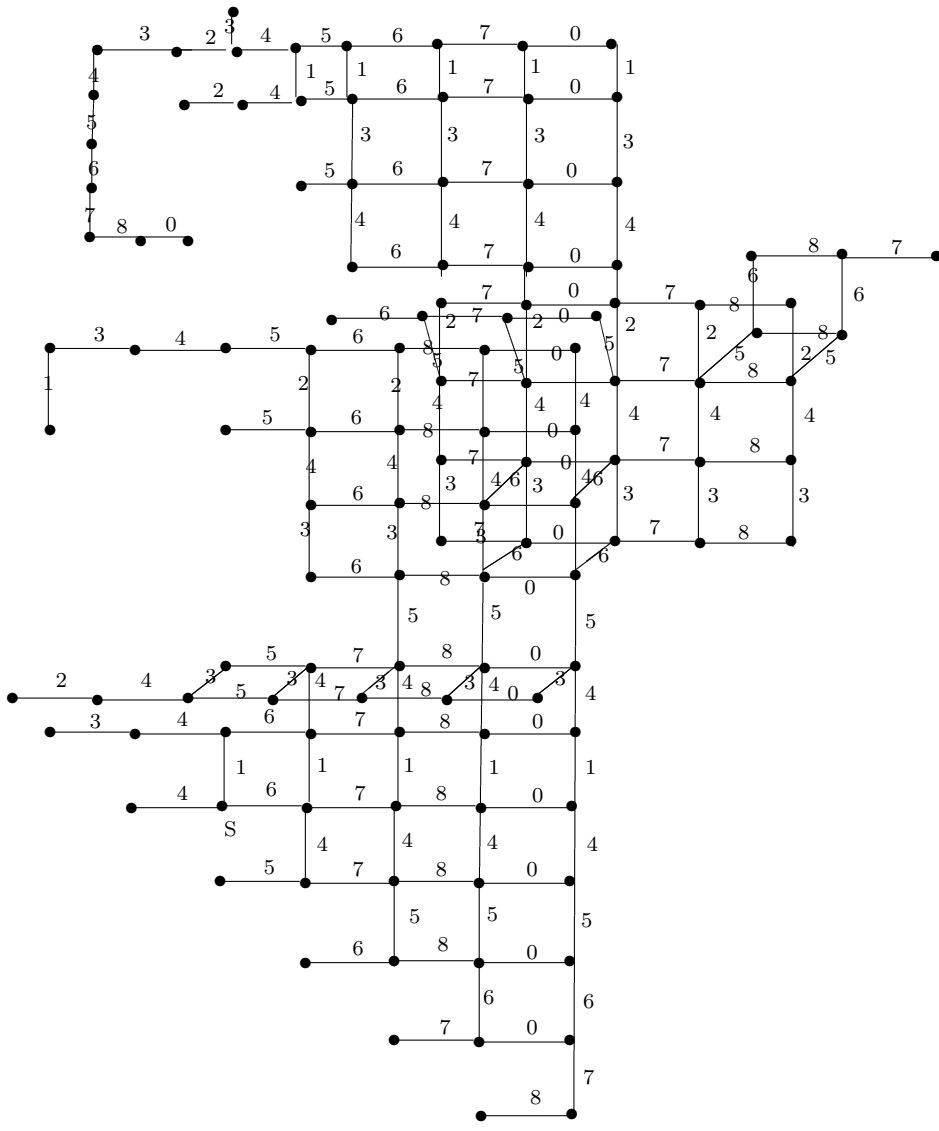

Figure.  $\tilde{E}_8, E'$